

***TECHNICAL
INFORMATION***

CITIZEN QUARTZ

Cal. No. 894 ※※

CITIZEN

§ 1. OUTLINE

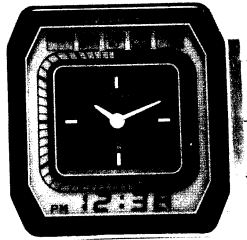

This is a multi-function and complex watch for gentlemen, which has been developed as a member of the well-reputed "89-series watches" combining the analog and digital watch functions together. It features the unique design and specifications plus application of the special-form drilled LC display panel and the analog electromagnetic correction system.

(Cal. 8940)

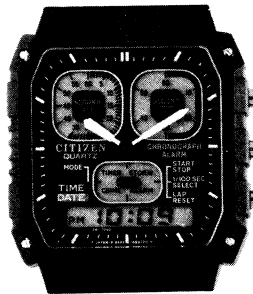

One of the biggest features of this watch is the LC (liquid crystal) display panel that doubles a dial plate, thus obtaining more variety of designs of watch by changing the print colors of the LC display panel (upper surface of the upper deflecting plate). (Cal. 8943)

§ 2. FEATURES

- 1) The electronic watch of quartz crystal oscillation type with no center second and LC (liquid crystal) display.
- 2) Analog watch section:
 - 20-second step movement with no center second.
 - The time correction applies the electromagnetic correction system by push-buttons.
 - The 0-second resetting of the analog section couples that of the digital section.
 - The simplification is realized for the movement with disuse of the dial-side mechanism.
- 3) Digital watch section:
 - The quick and analog-type reference is possible for the present time with application of the circle segment to the second display.
 - With the normal time display, the calendar display, the alarm, the timer and the stopwatch each. The simultaneous use is possible for both the timer and the stopwatch.
 - The 12-/24-hour switching function applied (with interlocking of the alarm display to the period switching of the time display).
 - The fully automatic calendar incorporated (including the leap years).
 - The quick setting system functions in the correction mode.
- 4) The number of component parts is reduced with facilitation attained for the disassembly and assembly by adapting the hook-system for both the LC display panel supporter and the supporter for plate complete (I).
- 5) The power cell life indicator functions through flashing of the colon at the digital display part when the output voltage of the power cell lowers.
- 6) The alarm monitor is incorporated.

§ 3. SPECIFICATIONS

Caliber No.	8940A/C-02		8943-02	
Module	Size	: 27.4 x 26.0mm	←	
	Thickness	: 4.55mm (Power cell part 4.75mm)	5.05mm (5.25mm)	
Accuracy	±15 sec./month at normal temperatures		←	
Oscillation	32,768Hz		←	
Digital section	Method of display	EF twist-type nematic LC (2-split multiplex driving)	←	
		4 digits +60 (circle segment) + 13 marks	66 (circle segment)	
	Display functions	Time	AM/PM, hour, minute/second (circle segment) plus 12/24-hour switching function	←
		Calendar	Date/day plus month & year (1980~2019) at moment of correction	←
		Alarm	AM/PM, hour & minute (12/24-hour switching function coupling to time display)	←
		Chime	ON/OFF	
		Timer	Hour, minute & second (circle segment) with 12-hour subtraction system	←
Stopwatch	Minute, second/1/100 sec. (by switch of display modes) with 60-min. counting	←		
Analog section	Means of display	Hour & minute hands with 20-sec. movement	←	
	Correction/setting of display	Electromagnetic method with push of button	←	
	Converter	Bipolar step motor	←	
Additional functions	<ul style="list-style-type: none"> •Power cell life indicator •Alarm monitor •12/24-hour switching function •Fully automatic calendar (1980~2019) •Instant manual return 		←	
Effective temperature range	±0°C ~ +60°C (32°F ~ 140°F)		←	
Integrated circuit	C/MOS-LSI (1 unit)		←	
Power cell	Parts No.	280-30 (SR1120W) Ag ₂ O/KOH	←	
	Capacity	45mAH	←	
	Lifetime	About 2 years (90-sec. ring of alarm per day)	←	
	Nominal voltage	1.55V	←	
	Size	11.6φ x 2.1mm ^t	←	

The difference between Cal. Nos. 8940A and 8940C exists only in the LC display panel as follows.

Points of difference Cal. Nos.	LC display panel
	Print + reflecting plate color
8940A	Blue
8940C	Brown

Cal. 8940

(LC display panel)

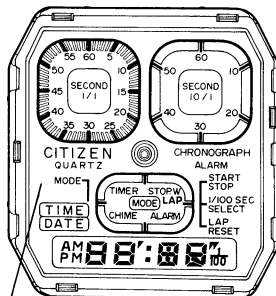

Color (printed on upper face of upper deflecting plate) differing at this area

•Combination between LC display panel (4 types) and reflecting plate

Color of LC display panel (Parts No.)	Color of reflecting plate
Black (281-706)	Silver
Birdy brown (281-708)	Gold
White (281-709)	Silver
Gray (281-711)	Silver

Cal. 8943

§4. HANDLING INSTRUCTIONS (The flashing area is shown by ○.)

1) Nomenclature (Cal. 8940)

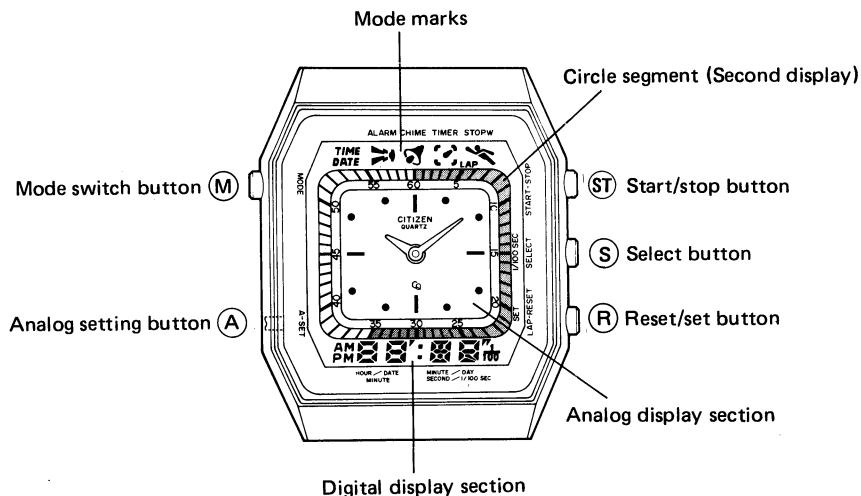

2) Switching of display

The switching is given to each display by pushing (M) button.

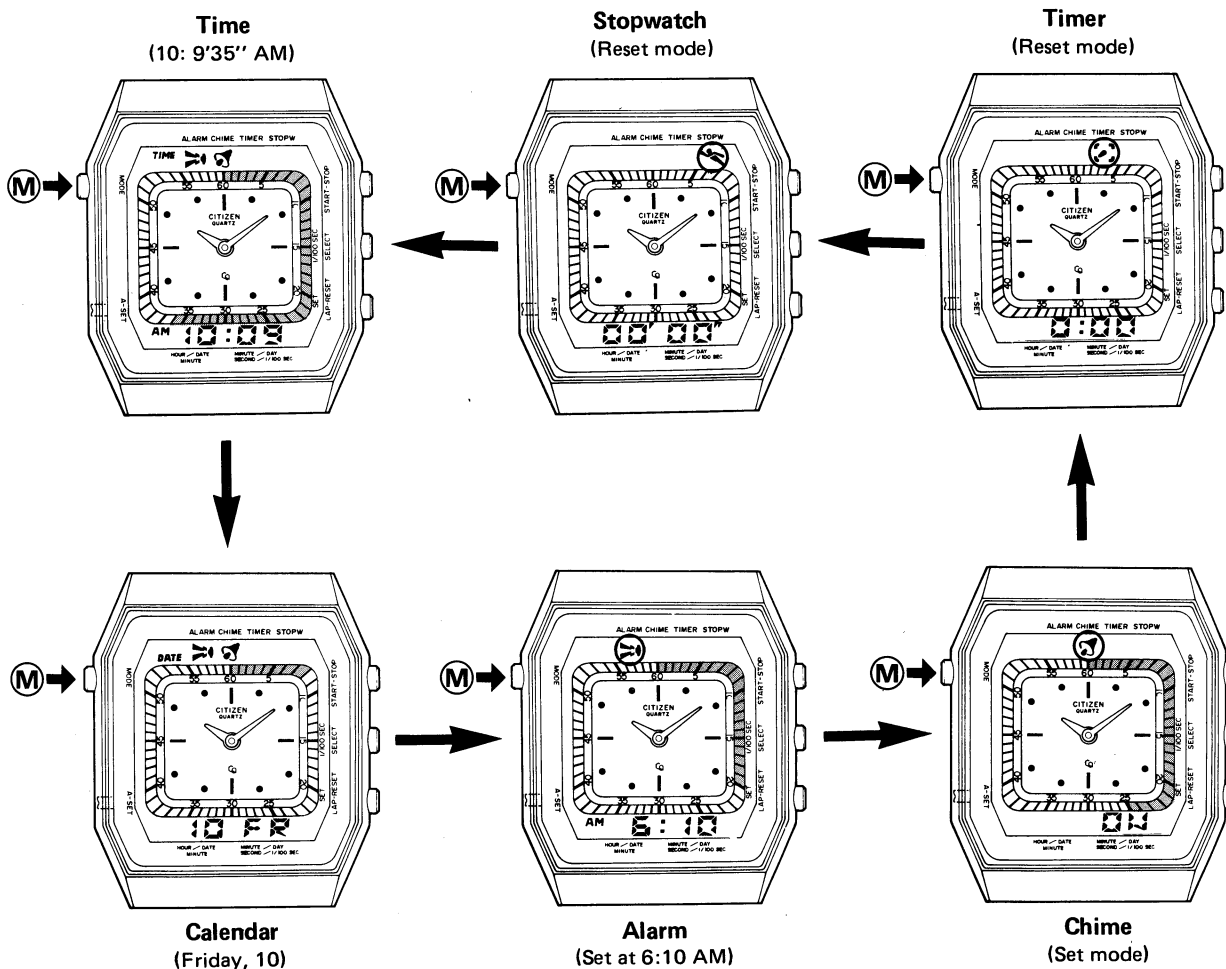

3) Nomenclature (Cal. 8943)

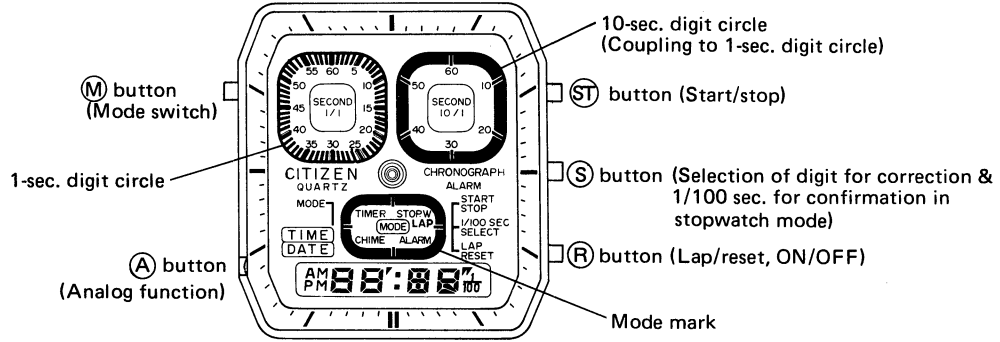

4) Mode switching

The mode of display is switched in the following sequence with every push of (M) button.

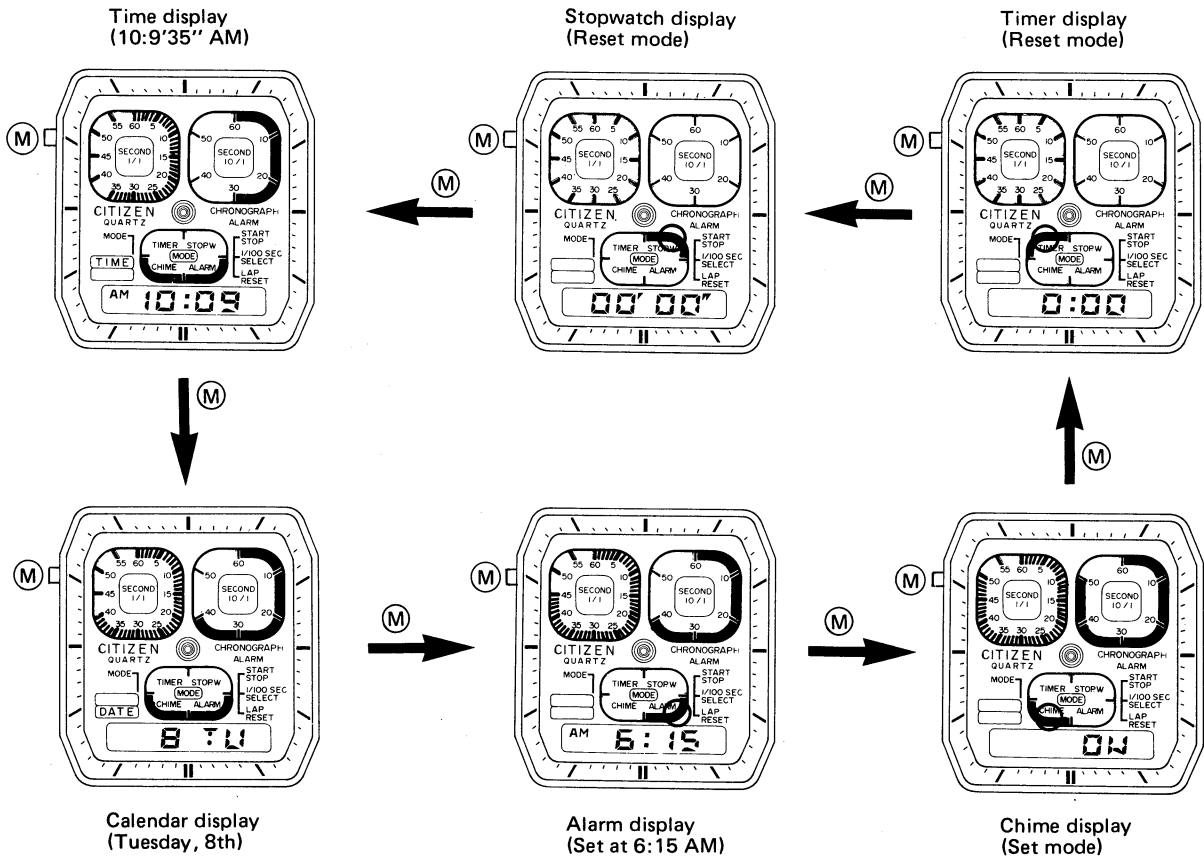

(The flashing area is shown by ○)

The handling method of the digital section is described via the diagram below.

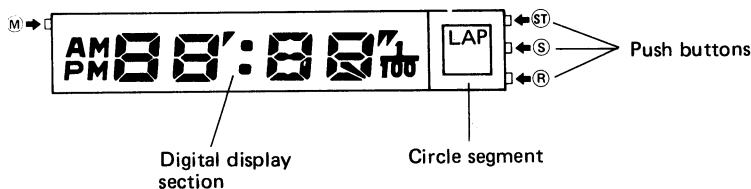

● 12-/24-hour switching

With simultaneous push of both (R) and (ST) buttons in the mode of the normal time display, the switching is possible between AM/PM 12H and 24H. The AM/PM is not displayed in the 24 hour display.

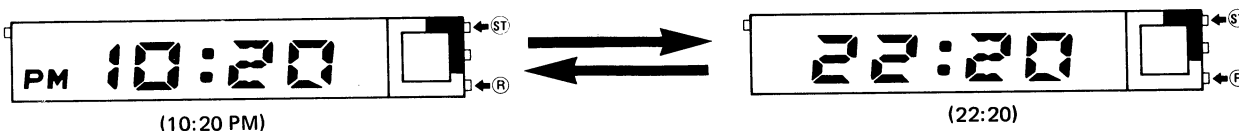

The alarm rings for the alarm monitor while the buttons are pushed.

● Alarm monitor

The circle segment shown in the right diagram blinks in a 1/4 cycle with a simultaneous push of (ST) and (R) buttons and in any mode of display. At the same time, an alarm monitor tone (sound of confirmation) identical to an alarm tone is produced.

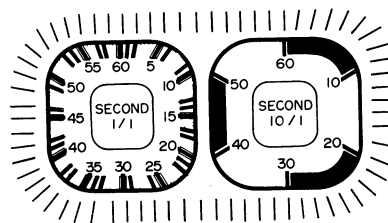

3) Time setting

Digital section

The time can be set via (R) button after calling out the digit to be corrected with push of (S) button.

The quick setting (8Hz signal) is possible with push of (R) button for more than about one second in the setting mode. In this case, the flashing ceases.

The setting is carried out in the following sequence.

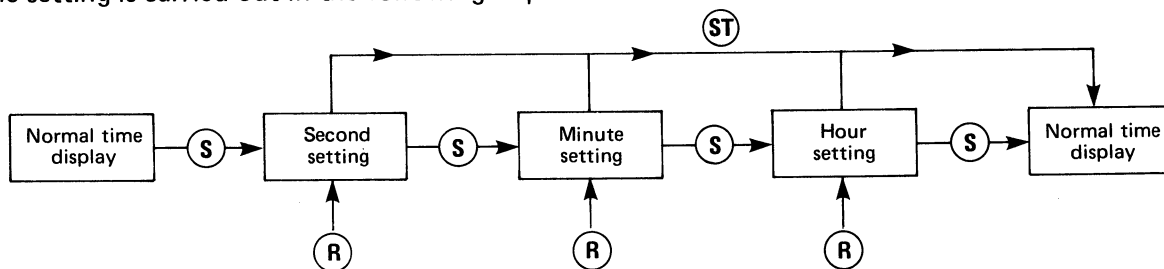

* (S)-button must be pushed for about one second to call out the second setting.

- The circle segment performs the sequential cumulative display of one segment per second to secure the full glowing at 60 seconds and then the full lights-out after 0.5 second, and then carries out the cumulative display again from one second.
- One minute is carried in case the 0-second resetting is carried out in the range of 30 ~ 59 seconds.

[Analog section]

- The application is possible for the "dual time" since the digital and analog watch sections can be set independently.

[Time setting]

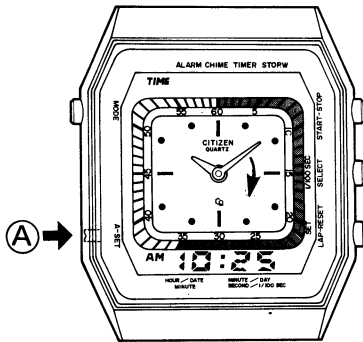

The setting is possible in any display mode with push of (A) button. However, the first push of the button functions to stop the alarm ringing when the alarm is ringing.

And the quick setting mode is secured if (A) button is pushed for about one second or more. For the fine adjustment, 20 seconds are advanced with every single-shot of push. The time setting is possible only forward (the direction indicated by the arrow in the left diagram)

Setting of same time for both analog and digital watch sections:

The digital time is set first, and then the analog time is set to the digital time.

(Ex.) Setting of analog minute hand at digital time of 00:15'N"

Digital "minute"	Digital "second"	Setting of analog minute hand
15	$0 \leq N < 20$	To be set to position of 15 minutes
	$20 \leq N < 40$	One push given after setting the minute hand to position of 15 minutes
	$40 \leq N < 60$	Two pushes given after setting the minute hand to position of 15 minutes

- "Second" setting

The 0-second resetting is also given at the analog section in coupling to setting of the digital "second". This method is applied to correction of the normal gains or losses.

In case the 0-second resetting is given at N second, the analog and digital changes are as shown below.

Before 0-second resetting	After 0-second resetting		
Digital "second"	Digital "second"	Digital "minute"	Analog "minute"
$0 \leq N \leq 29$	00	No change	Waiting for N-second counting(*1)
$30 \leq N \leq 39$	00	Carry of one minute	+2(*2)
$40 \leq N \leq 59$	00	Carry of one minute	+1

(*1) The count waiting is cancelled in case the analog setting is carried out during the count waiting.

(*2) This watch features 20-second step movement, and accordingly 20 seconds advance with every step movement of the hands.

In this connection, the two movements (40 seconds) are given if the 0-second resetting is carried out in the range of 30 ~ 39 seconds.

4) Calendar setting

The digit to be corrected is called out with push of (S) button, and then the setting is carried out with push of (R) button.

- The setting of the years is possible from 1980 to 2019.
- In case the non-existing day is set, the first day of the following month is set in the normal calendar display.

The quick setting is possible by pushing (R) button for about one second or more in the setting mode.

The setting is carried out in the following sequence.

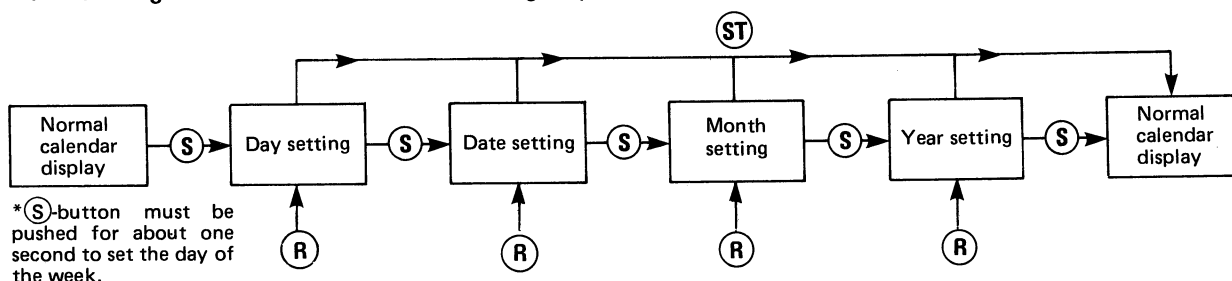

5) Alarm operation

(1) ON and OFF of alarm

The ON (setting time display) and OFF of the alarm function are switched alternately with every push of (R) button in the mode of the alarm normal display.

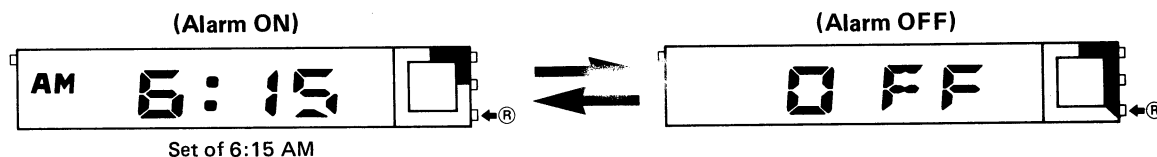

(2) Setting of alarm

The digit to be corrected is called out with push of (S) button, and then the setting is carried out via (R) button.

- The alarm mark is shown under the time/calendar display and when the alarm is ON.
- The switching between AM/PM 12H and 24H interlocks the period system of the time display.

The quick setting is possible by pushing (R) button for about one second or more in the setting mode.

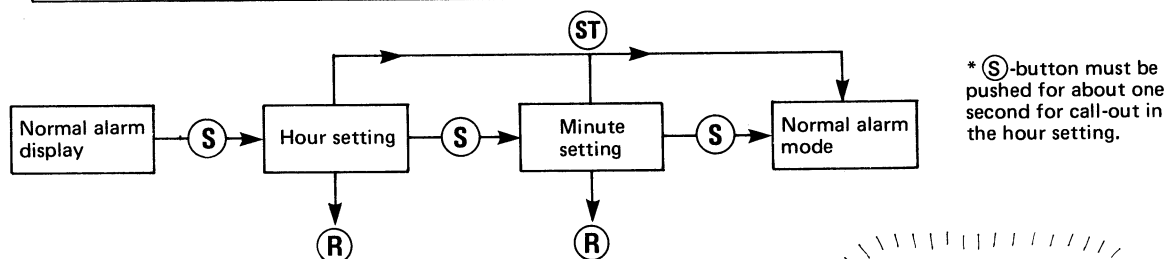

In the alarm ringing state, the segments feature the ¼-second synchronous flashing with every two segments for the circle segment as shown in the right diagram.

The alarm ringing can be stopped anytime by pushing any of the push-buttons.

(The same flashing is given also at the time-up moment of the timer function or the alarm monitor.)

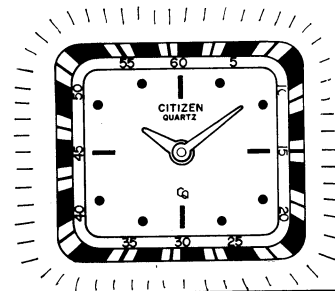

6) Setting of chime

The ON and OFF switch alternately with every push of (R) button in the chime display mode. In the mode of ON, the alarm sounds twice in synchronization with every hour on the hour.

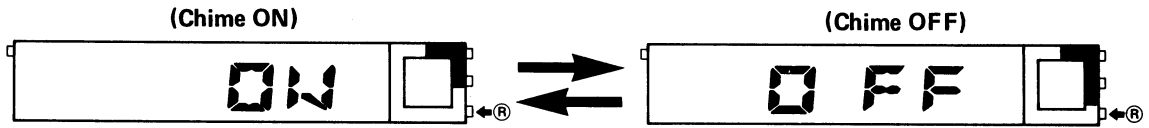

7) Operation of timer

- The timer can be set to the minimum one second to the maximum 11H 59'59".
- The alarm rings for 10 to 20 seconds at the time-up moment. The original set time is displayed as soon as the alarm ring ceases to be kept as it is. The alarm ring can be stopped any time with push of any button.

(1) Push button operation of timer

- The following five modes are shown in the timer display.

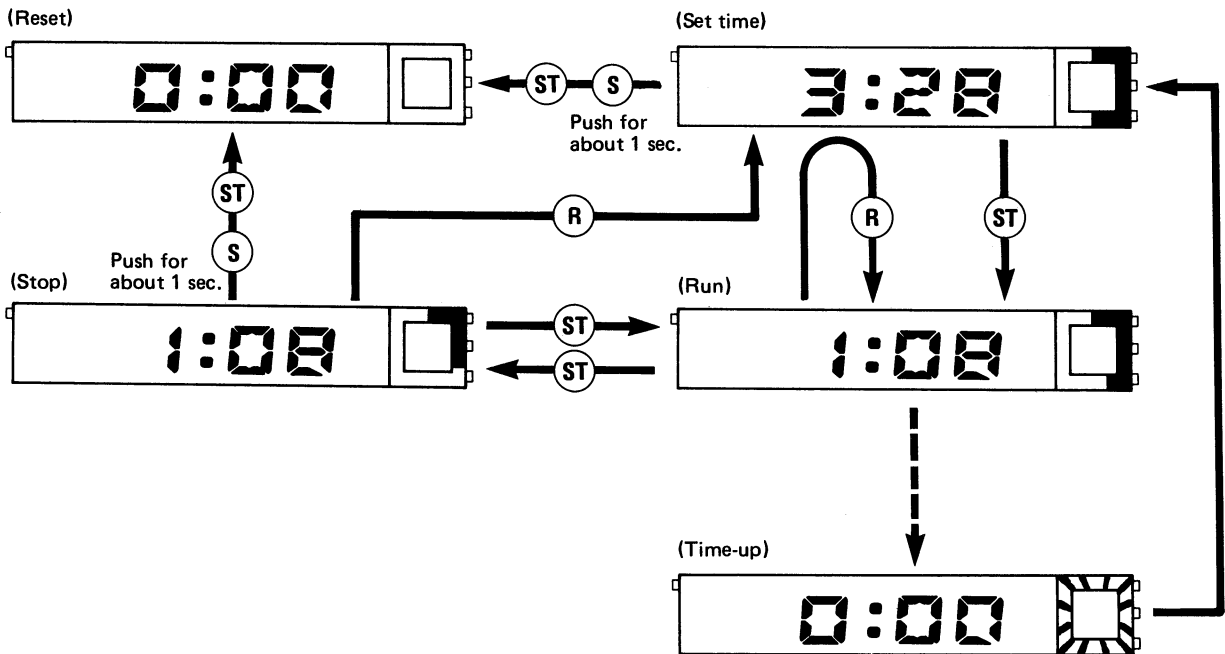

(2) Setting of timer:

- The correction is done individually for each digit through the subtracting method.
- Never fail to secure the displays of "set time", "stop" and "reset" each before setting the timer.
- The digit to be corrected is called out with push of (S) button, and then the setting is carried out with push of (R) button.

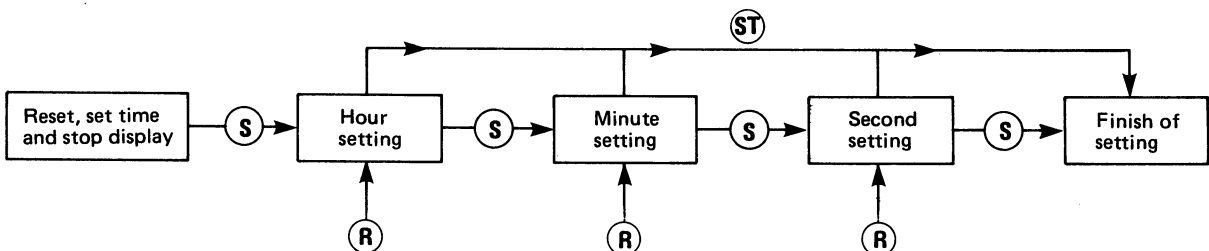

* (S)-button must be pushed for about one second for call-out in the hour setting.

8) Operation of stopwatch

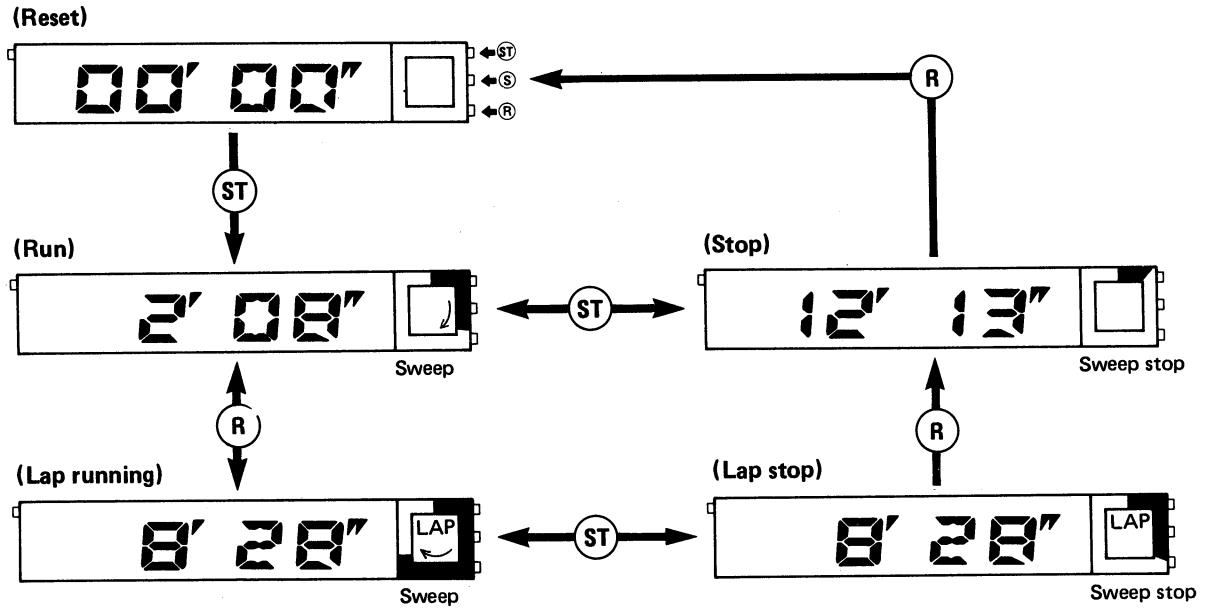

(Call-out of 1/100 sec.)

The "minute/second" display is switched to the "1/100 sec." display while (S) button is pushed and regardless of the "run" or "stop" mode.

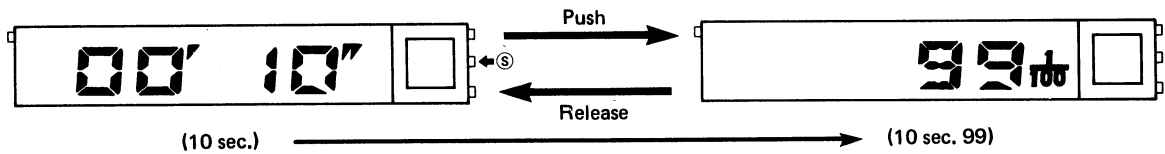

(Sweep display)

The circle segment performs the following displays in the one-second cycle in the mode of "run" ("lap run") and under use of the stopwatch.

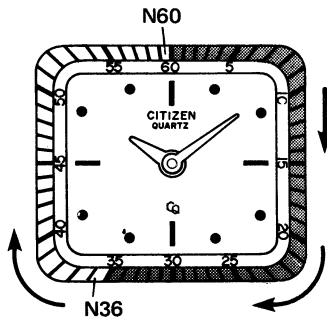

- 1/100 sec ~ 60/100 sec.
Sequent and cumulative glowing is given to the segments from N1 and every 1/100 sec.
- 60/100 sec. ~ 79/100 sec.
All segments of N1 ~ N60 glow.
- 80/100 sec. ~ 100/100 sec.
All segments of N1 ~ N60 are turned out.

The display is discontinued with the cumulating part kept glowing (or turned out) in the mode of the "stop" ("lap stop").

For a count-down action of the timer, the 10-sec. digits are turned off by an amount equivalent to 10 seconds when the 1-sec. circle segment advances by 1 second in the 10-sec. unit (60, 50, 40 . . . 10 seconds) as illustrated right.

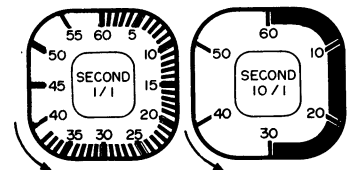

§ 5. STRUCTURE OF MOVEMENT

1) Circuit diagram

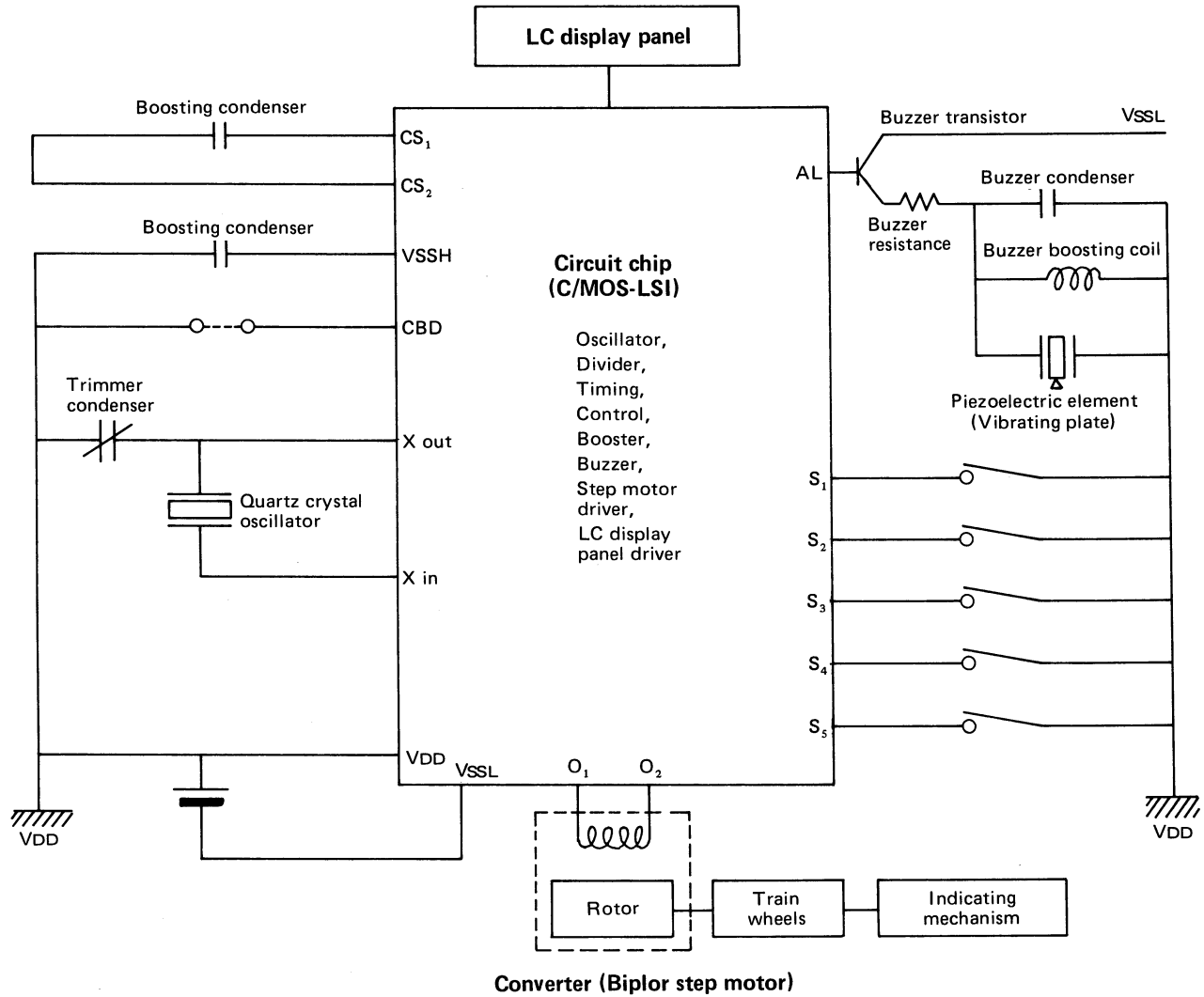

2) Movement

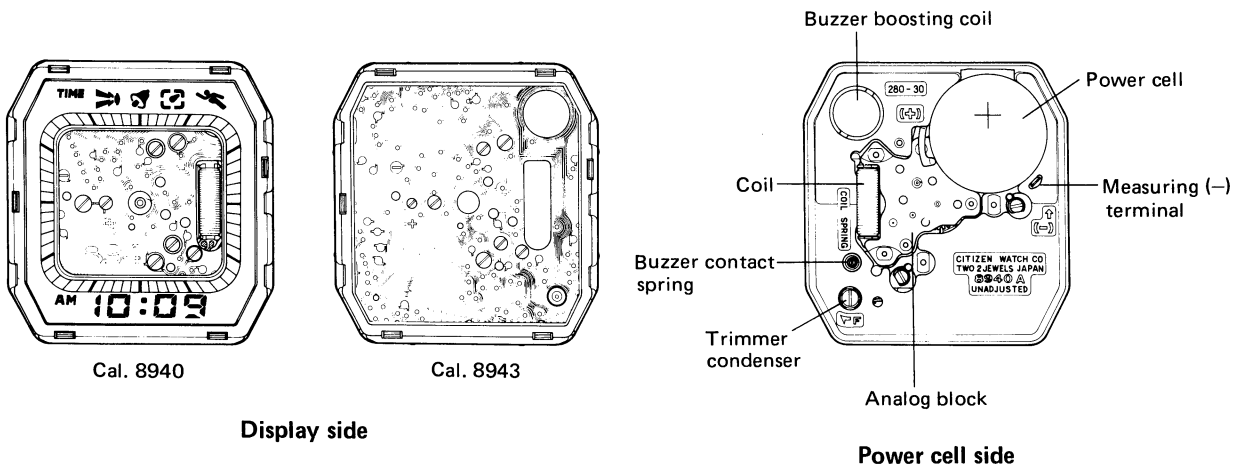

§ 6. DISASSEMBLING/ASSEMBLING PROCEDURE OF MOVEMENT

1. Power cell side

Disassembling sequence: ① ~ ②②
 Assembling sequence: ②② ~ ①

The buzzer contact spring is set after ②.

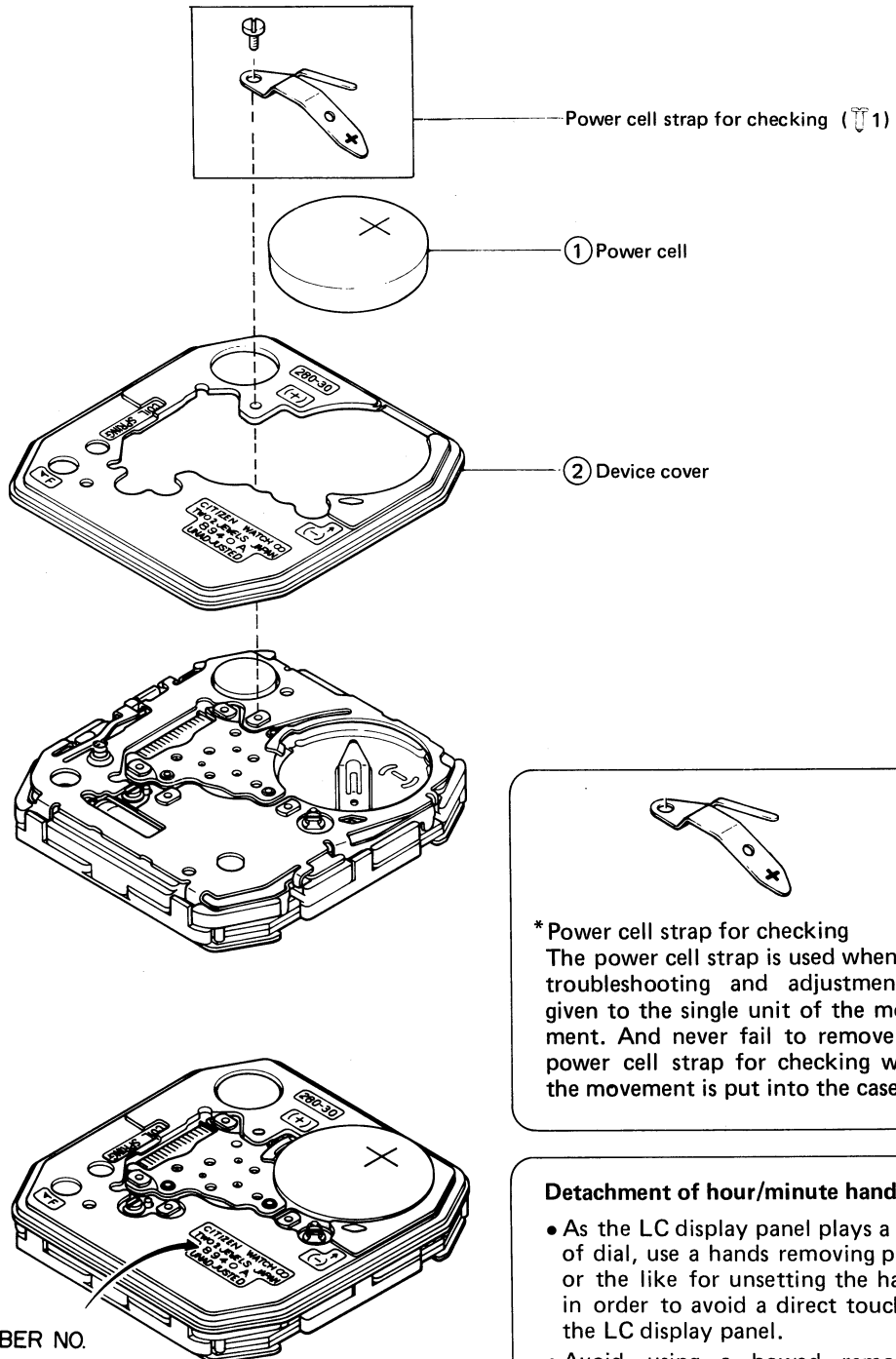

***Power cell strap for checking**
 The power cell strap is used when the troubleshooting and adjustment is given to the single unit of the movement. And never fail to remove the power cell strap for checking when the movement is put into the case.

Detachment of hour/minute hands

- As the LC display panel plays a role of dial, use a hands removing pliers or the like for unsetting the hands in order to avoid a direct touch to the LC display panel.
- Avoid using a bowed removing hands to avoid the breakage of LC display panel.

2. LC display panel side

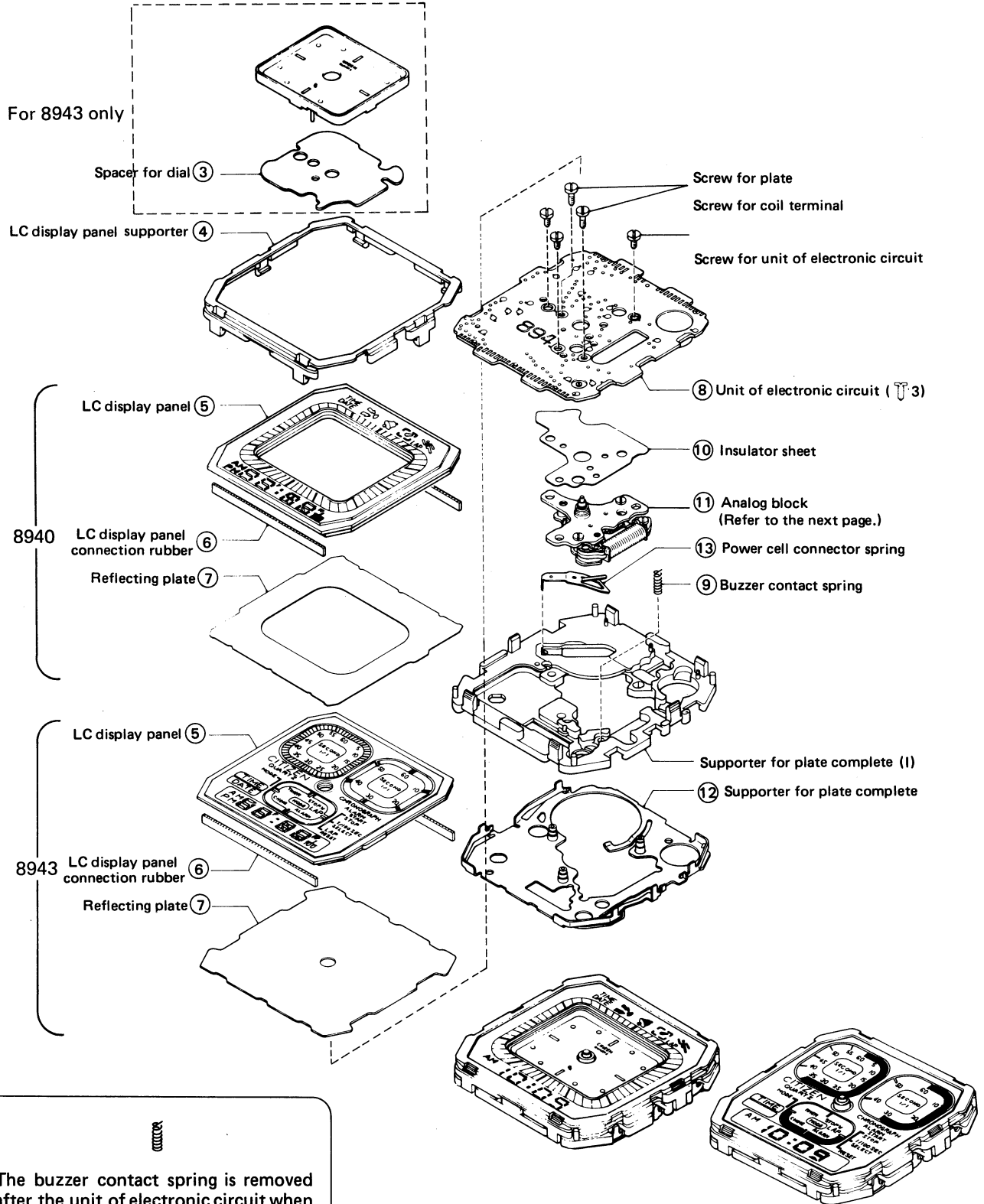

The buzzer contact spring is removed after the unit of electronic circuit when disassembling and set after the device cover when assembling respectively.

3. Analog block

Lubrication marks

- Ⓐ : Synt-A-Lube oil
- Ⓥ : Synta-V-Lube oil

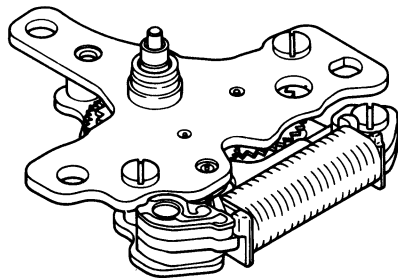
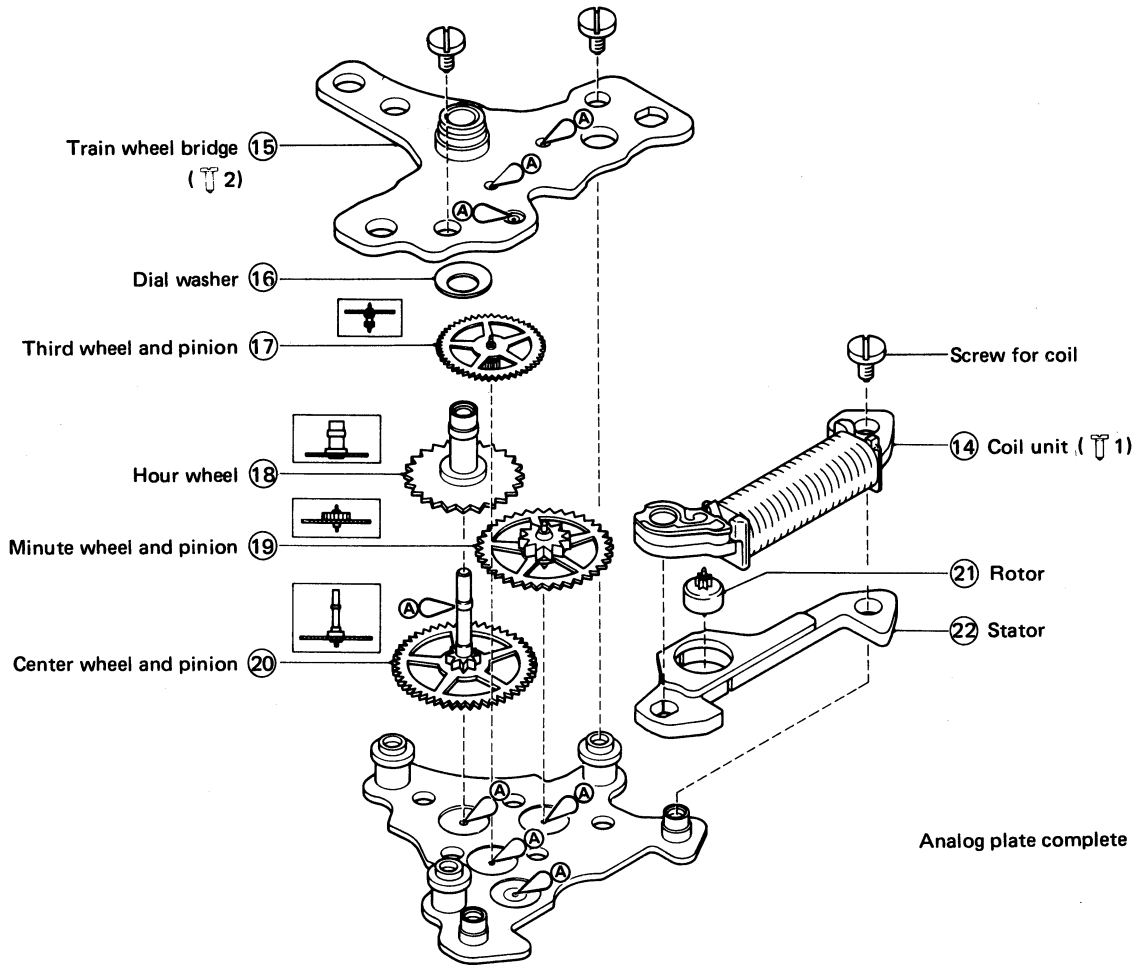

§7. NOTES ON ASSEMBLING AND DISASSEMBLING

1) Structure of LC display panel holder (Hook type)

In this caliber, the LC display panel supporter is hooked to the supporter for plate complete (1) at six areas as illustrated to hold the LC display panel. When assembling, the LC display panel supporter is pushed for setting while paying attention to the cracking of the display panel or the bend of the LC display panel connection rubber and others.

And the LC display panel supporter can be removed easily from the power cell side by being hooked light by the tweezers, the driver or the like.

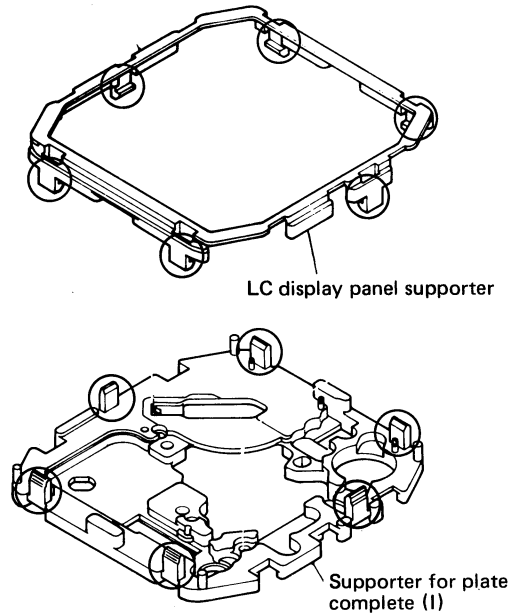

Fig. 1

2) Handling of buzzer contact spring

•The buzzer contact spring is removed after the unit of electronic circuit when disassembling and set after the device cover when assembling respectively.

•How to set buzzer contact spring

(1) The buzzer contact spring is held with the hooking part of the spring put downward. (Fig. 2)

(2) The spring is tilted and then the hooking part of the spring is put first into the hole of the device cover. Under these conditions, the whole part of the spring is pushed into the hole. (Fig. 3)

(3) After pushing the spring into the hole, make sure that the spring is set completely by picking the spring. The spring must not be taken out although it may be pulled up and also must have some play.

Finally, the alarm ringing must be confirmed through the sound monitoring (Simultaneous push of both **ST** and **R** buttons).



Fig. 2

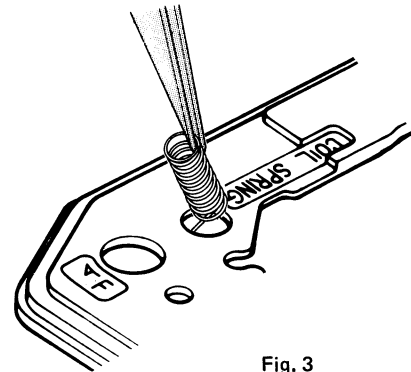
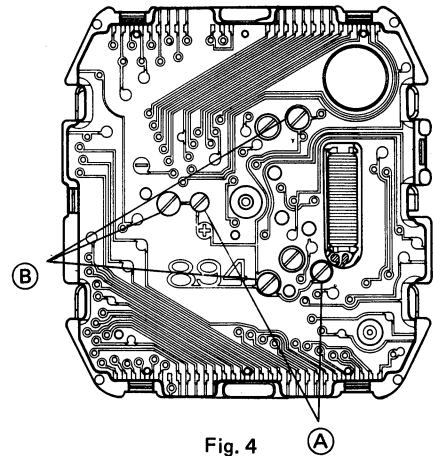
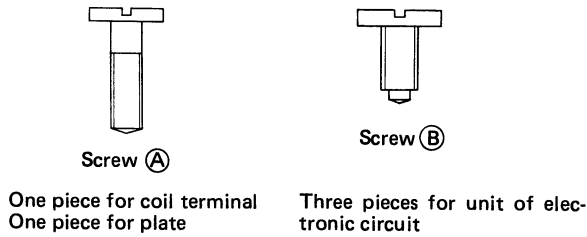

Fig. 3

- 3) Notice that two different types of screws (A) and (B) are available for the unit of electronic circuit. (Fig. 4)



The screw for coil terminal must be driven completely since it doubles the electric junction between the analog coil and the unit of electronic circuit.

- 4) The dial is fixed by the dial fixing axes (eccentric) at two areas as shown in Fig. 5. The dial is attached and detached by turning the dial fixing axes with the driver.

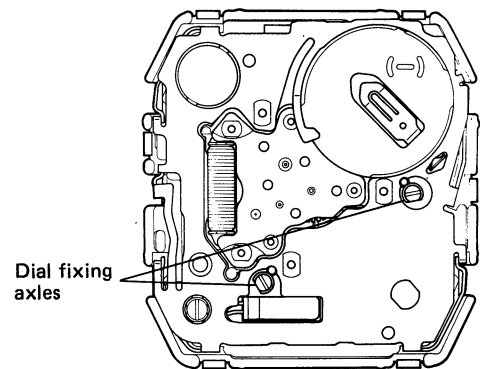

- 5) The switch spring must be set first to the stopper part when the supporter for plate complete is set into the supporter for plate complete (I). (Fig. 6). The assembling must be carried out so that the switch spring may not come off and while the area near the center of the supporter for plate complete is being pushed.

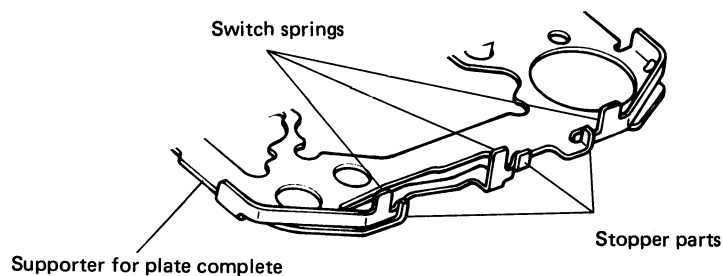

§ 8. TROUBLESHOOTING AND ADJUSTMENT

1) Flow chart of troubleshooting and adjustment

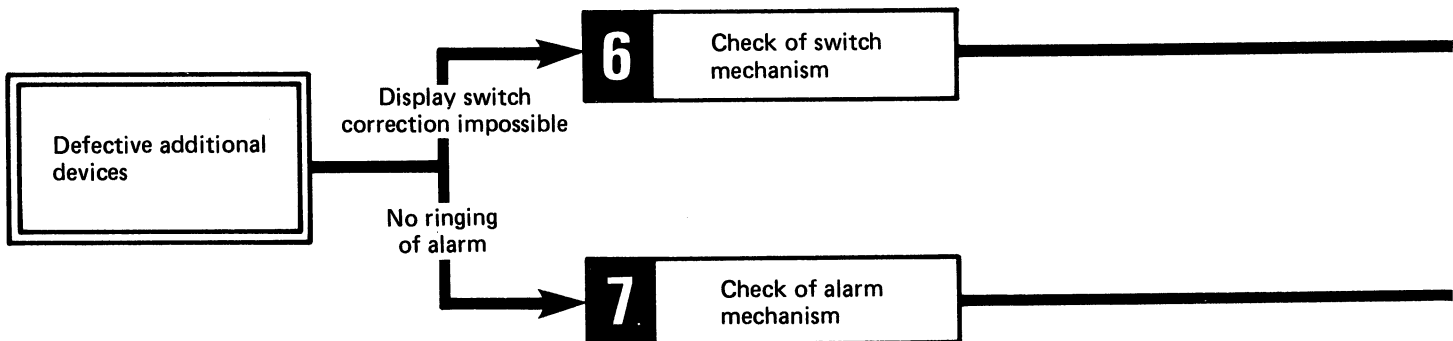
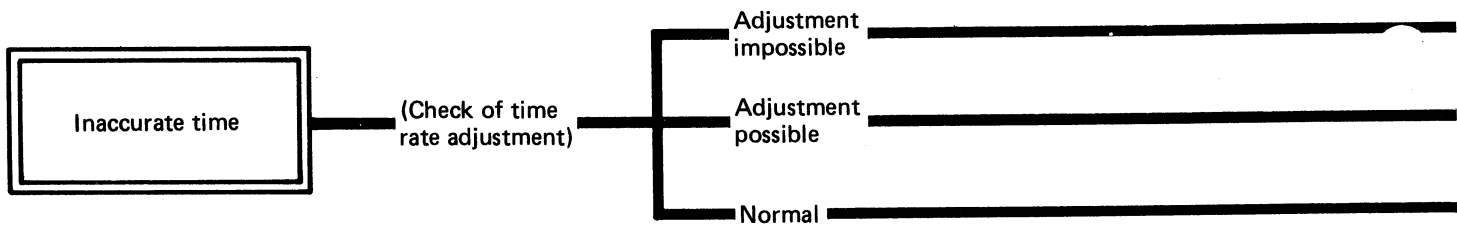
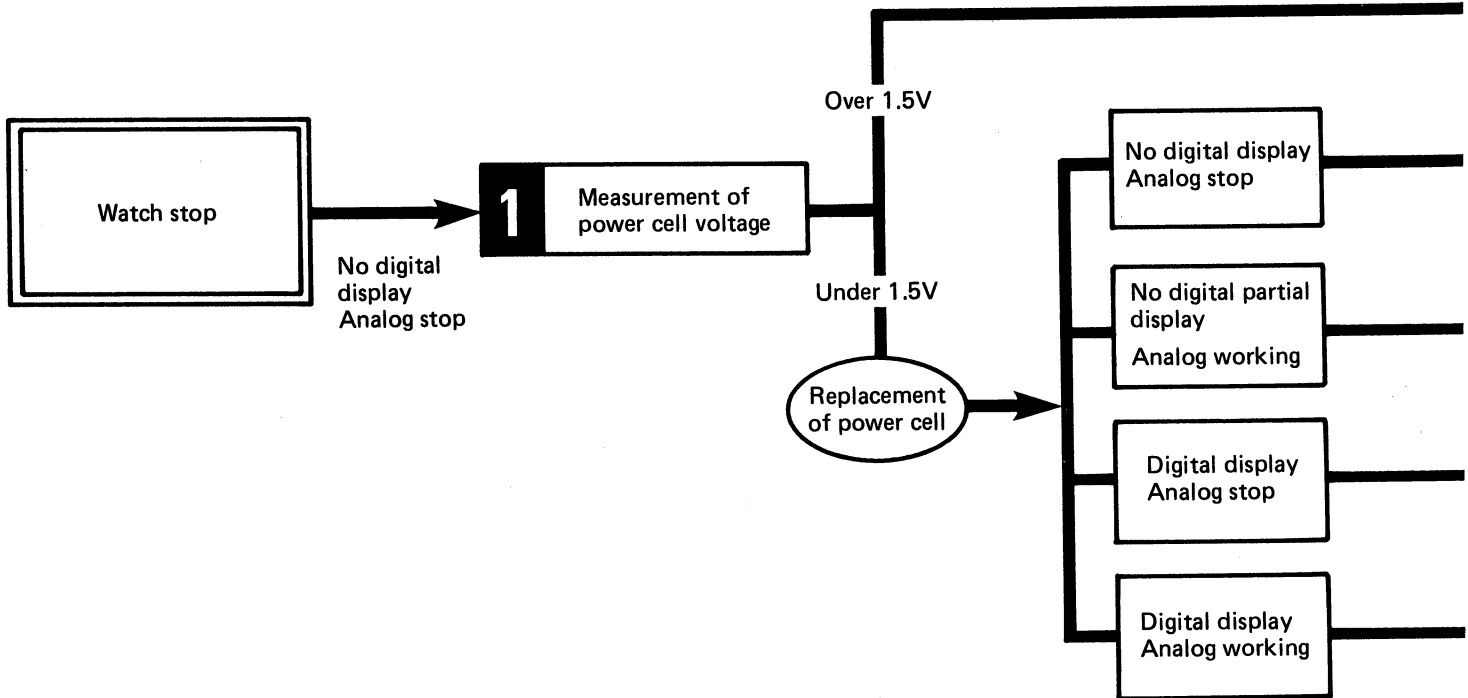

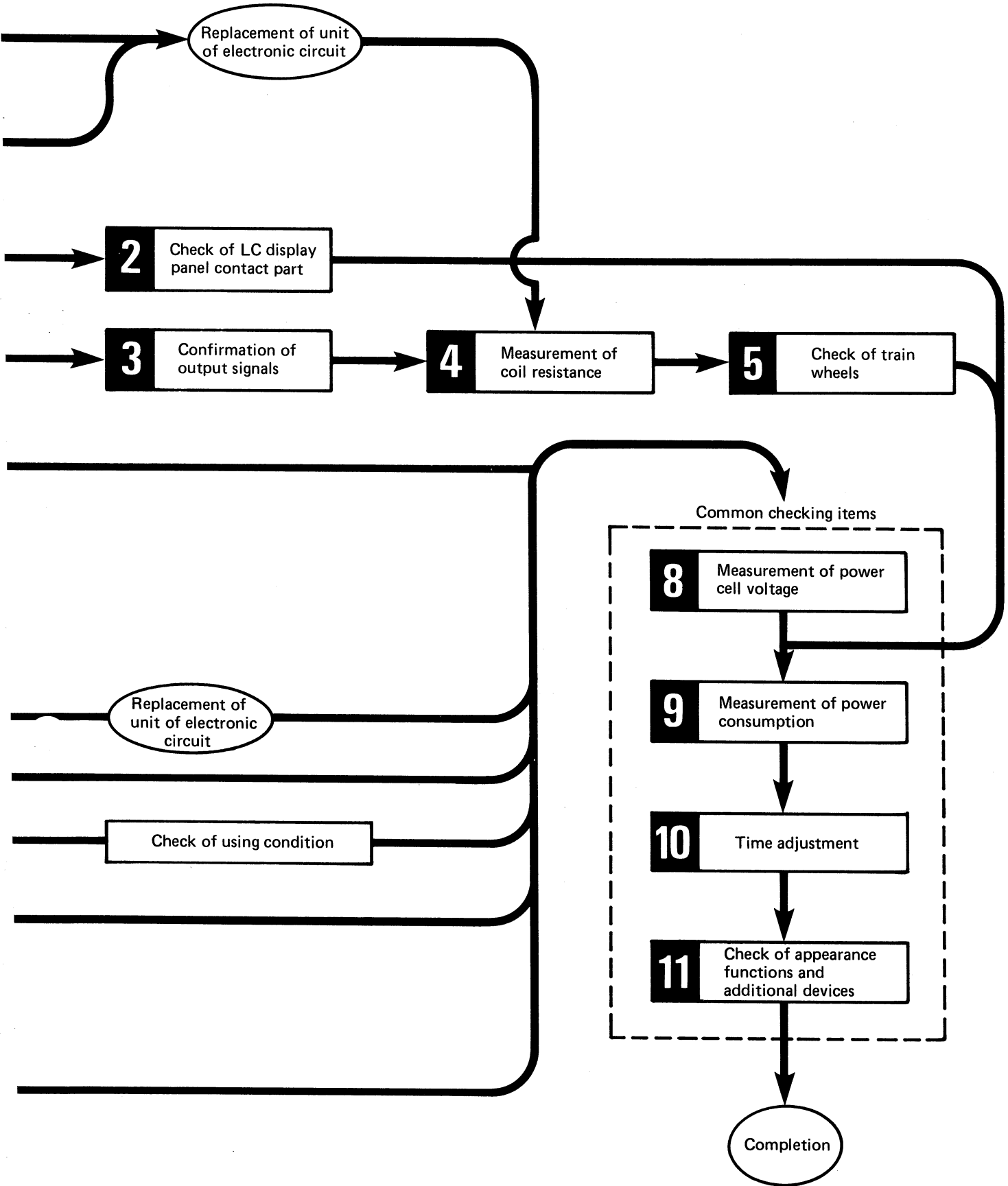

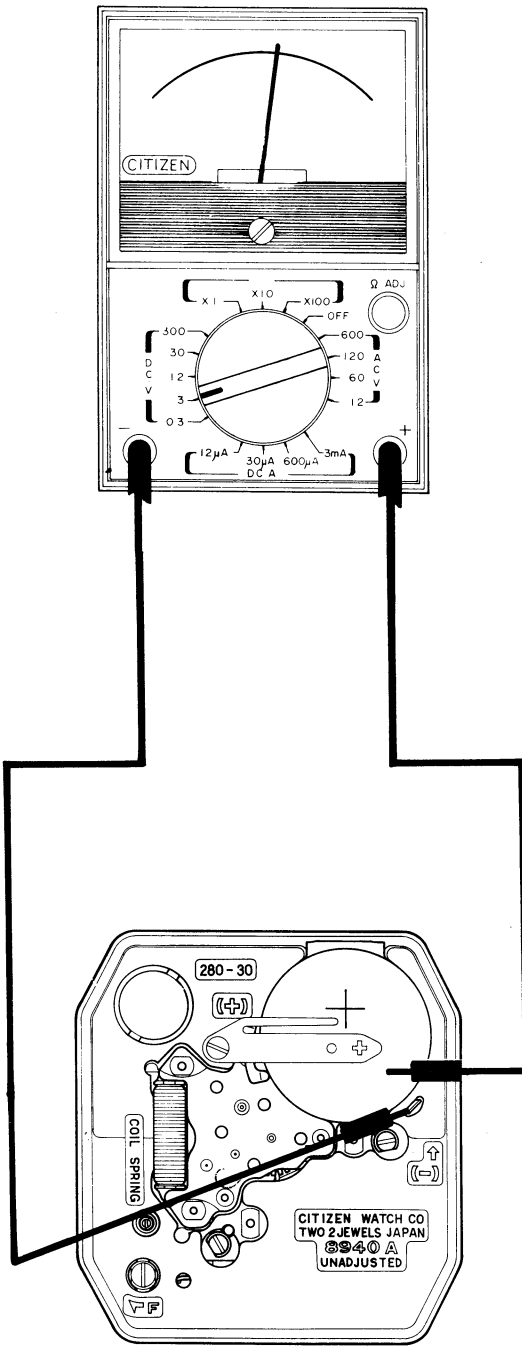
Checking items	How to check	Result and treatment
<p>1 Measurement of power cell voltage</p>	<div style="text-align: center;">  </div> <p>(The measurement must be carried out after setting the device cover.)</p>	<div style="display: flex; flex-direction: column; align-items: center;"> <div style="display: flex; align-items: center; margin-bottom: 20px;"> <div style="border: 1px solid black; padding: 2px 5px; margin-right: 10px;">Over 1.5 V</div> <div style="margin-left: 20px;">→ Normal</div> </div> <div style="display: flex; align-items: center;"> <div style="border: 1px solid black; padding: 2px 5px; margin-right: 10px;">Under 1.5V</div> <div style="margin-left: 20px;">→ Replacement of power cell</div> </div> <div style="border: 1px solid black; padding: 10px; margin-top: 20px; width: 80%; text-align: center;"> <p>Note</p> <p>If the watch measured has been used more than two years, the power cell must be replaced with new one although the old power cell shows more than 1.5V output.</p> </div> </div>

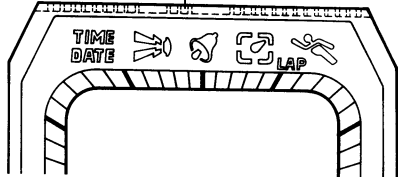
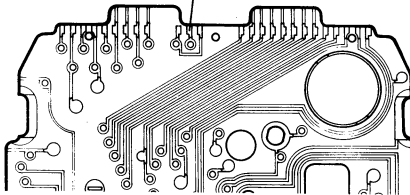
Checking items	How to check	Result and treatment
<p>2 Check of LC display panel contact part</p>	<p>The checking is given to whether the complete contact is secured between the electrode part of the LC display panel and the pattern of the unit of electronic circuit.</p> <p>1) Check whether the LC display panel supporter and the LC display panel connection rubber are set in the correct way. Areas to be inspected: LC display panel supporter . . . 6 areas of hooking LC display panel connection . . Bend or fall rubber</p> <p>2) Check whether the LC display panel connection rubber has some twist or wear along with the dust or stains sticking to the connection rubber.</p> <p>3) Check whether the dust or stains stick to the electrode part of the LC display panel or has some cracking.</p> <p>A careful inspection must also given to the electrode part of the unit of electronic circuit.</p> <p>*The dust sticking to the electrode part must be removed away completely since it will cause the increment of the power consumption.</p> <div style="text-align: center;"> <p>Electrode part</p>  <p>Electrode part</p>  </div>	<p>Rubber twisted or worn out → Replacement of connection rubber</p> <p>Dust or stains → To be removed away</p> <p>Dust or stains → To be removed away</p> <p>Break or cracking detected → Replacement of LC display panel</p> <p>No display given even after above inspections → Replacement of LC display panel</p> <p>No correct display secured even after replacement of LC display panel → Replacement of unit of electronic circuit</p>

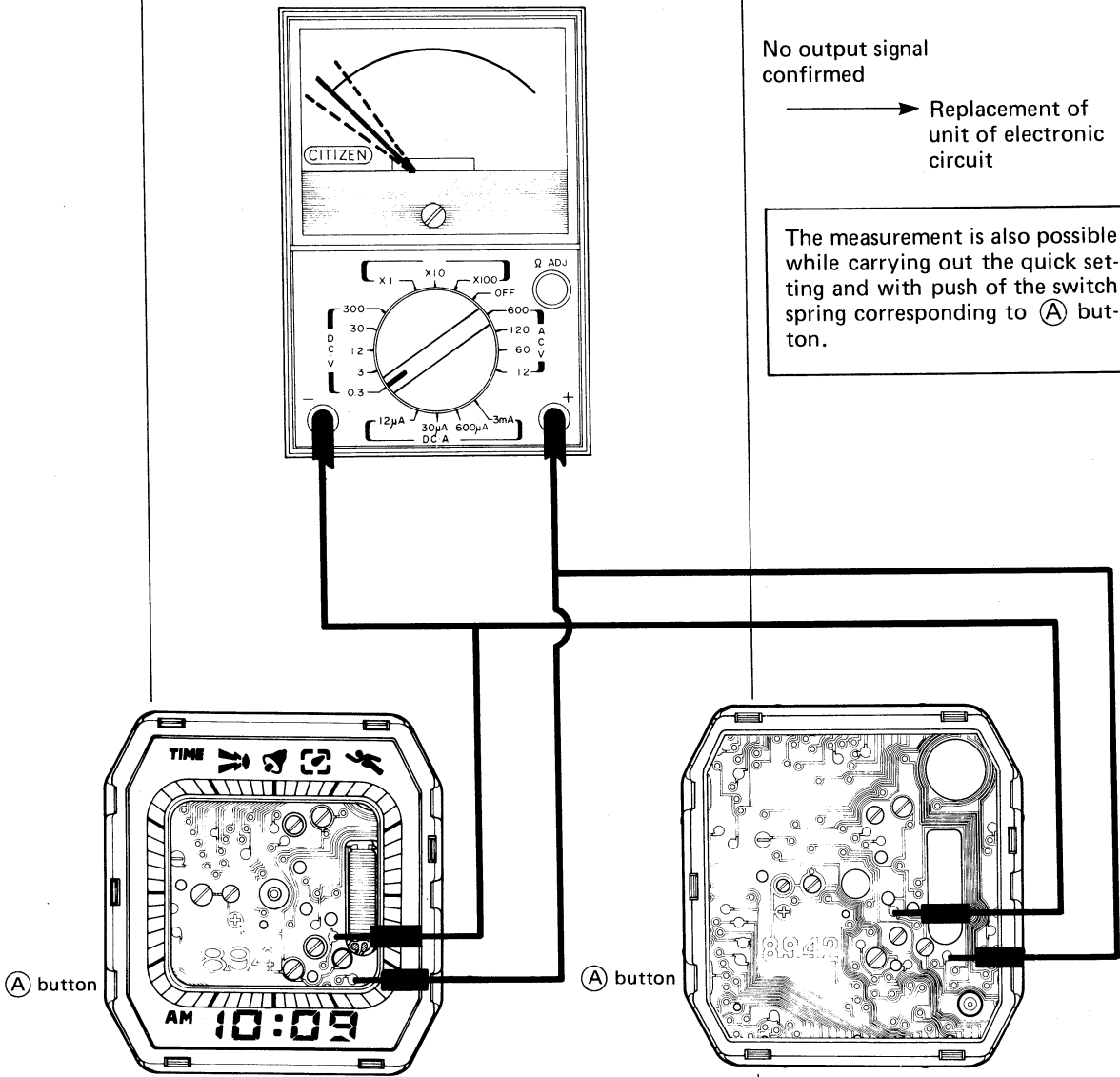
Checking items	How to check	Result and treatment
<p>3 Confirmation of output signal</p>	<p>The measurement must be carried out with the dial removed.</p> <p>If the tester pointer swings right and left every 20 seconds and centering on 0V, the output signal is normal.</p>  <p>(No discrimination required for polarities)</p>	<p>Output signal confirmed</p> <p>→ 4</p> <p>No output signal confirmed</p> <p>→ Replacement of unit of electronic circuit</p> <div style="border: 1px solid black; padding: 5px; margin-top: 10px;"> <p>The measurement is also possible while carrying out the quick setting and with push of the switch spring corresponding to (A) button.</p> </div> <div style="border: 1px solid black; padding: 5px; margin-top: 10px;"> <p>The LC display panel must be removed to confirm the output signal.</p> <p>(A quick measurement is possible in the quick setting mode that is obtained by pushing the switch spring corresponding to (A) button. Thus a consecutive deflection is obtained centering on 0V.)</p> </div>

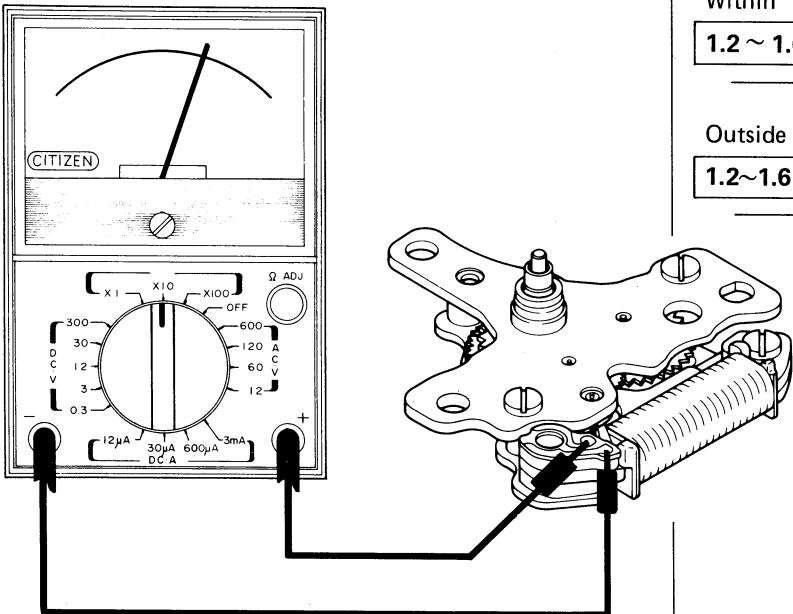
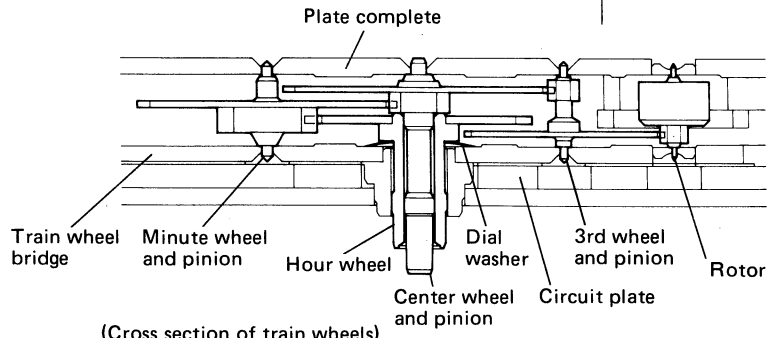
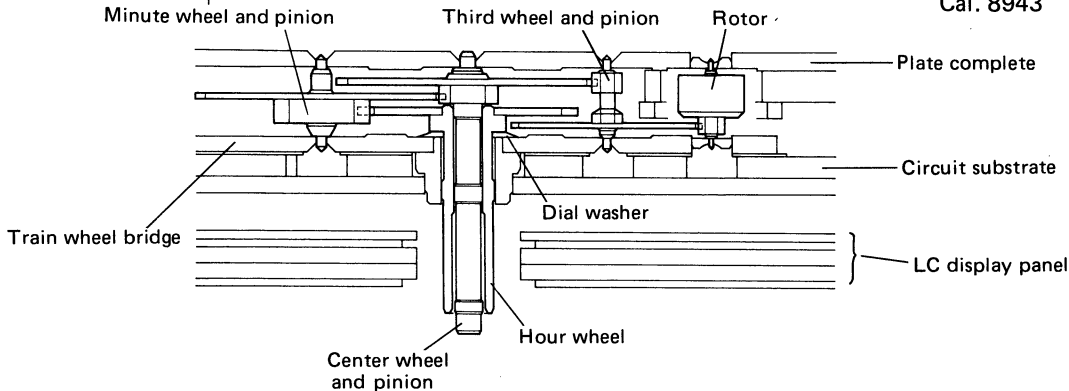
Checking items	How to check	Result and treatment
<p>4 Measurement of coil resistance</p>		<p>Within <div style="border: 1px solid black; padding: 2px; display: inline-block;">1.2 ~ 1.6kΩ</div> → Normal</p> <p>Outside <div style="border: 1px solid black; padding: 2px; display: inline-block;">1.2 ~ 1.6kΩ</div> → Replacement of coil unit</p>
<p>5 Check of train wheels</p>	<p>The following points are checked after taking out the analog block.</p> <ol style="list-style-type: none"> 1) Make sure that the transmission is smooth among the gears with the appropriate clearance and with no creak at all. 2) Make sure that no dust nor stains attach to each gear and that the lubricating condition is good. 3) Whether the dial washer is set in a correct way. 	<p style="text-align: right;">Cal 8940</p> <div style="text-align: center;">  <p>(Cross section of train wheels)</p> </div> <p style="text-align: right;">Cal. 8943</p> <div style="text-align: center;">  </div>

Display switch/correction impossible

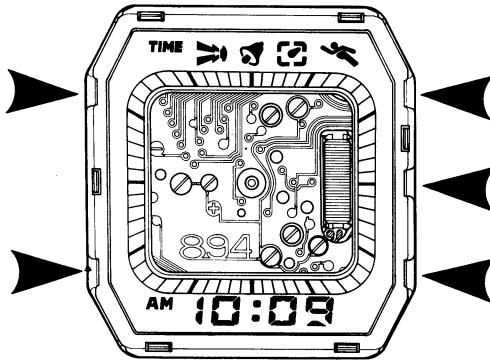
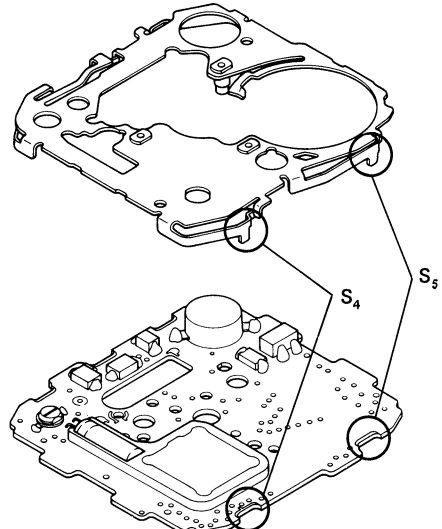
Checking items	How to check	Result and treatment
<p>6 Check of switch mechanism</p>	<p>1) Inspection of switch mechanism As illustrated below, the switch spring parts of the supporter for plate complete corresponding to each push-button via the tweezers or the like and in the single state of the movement. Thus the correct operation of each switch spring part can be confirmed.</p>  <p>2) Check of push-buttons</p> <ul style="list-style-type: none"> •The checking is given to the malformation of the push-buttons along with the dust or stains sticking to them. •Each push-button is set into the case to make sure the smooth operation of the button. <p>3) Check of switch spring mechanism</p> <ul style="list-style-type: none"> •Make sure that each switch spring is free from malformation and breakage. •The supporter for plate complete and the unit of electronic circuit are set. And make sure that each switch spring has the correct contact to the pattern of the unit of electronic circuit.  <p>S₄ : Mode change-over switch S₅ : Analog setting switch</p>	<p>Normal operation → 2) Check of push-buttons</p> <p>Abnormal operation → 3) Check of switch spring mechanism</p> <p>Malformation of push-button → Replacement of push-button</p> <p>Dust or stains sticking → To be removed</p> <p>Malformation or breakage of switch spring → Replacement of supporter for plate complete</p> <p>No fault detected through above inspections → Replacement of unit of electronic circuit</p>

No ringing of alarm

Checking items	How to check	Result and treatment
<p>7 Check of alarm mechanism</p>	<p>1) The movement is set to the case, and the alarm output is confirmed with the case back removed.</p> <p>(1) The ⊕ and ⊖ leads are applied to the power cell surface and the buzzer contact spring.</p> <p>(2) Both (R) and (ST) buttons are pushed simultaneously with the leads being applied (Sound monitor state). Thus the tester pointer swings by the degree equivalent to the duration of the alarm ring.</p>	<p>Pointer swinging</p> <p>→ No fault with unit of electronic circuit</p> <p>→ 2)</p> <p>No swinging of pointer</p> <p>→ Replacement of unit of electronic circuit</p> <p>2) The following points are checked in case no fault is detected through the inspections of 1).</p> <p>(1) Whether the piezoelectric element of the vibrating plate has some cracking or breakage.</p> <p>(2) Whether the buzzer contact spring has some bend or malformation and is set in the correct way.</p> <p>(3) Whether some dust or stains are sticking to the pattern of the unit of electronic circuit.</p>

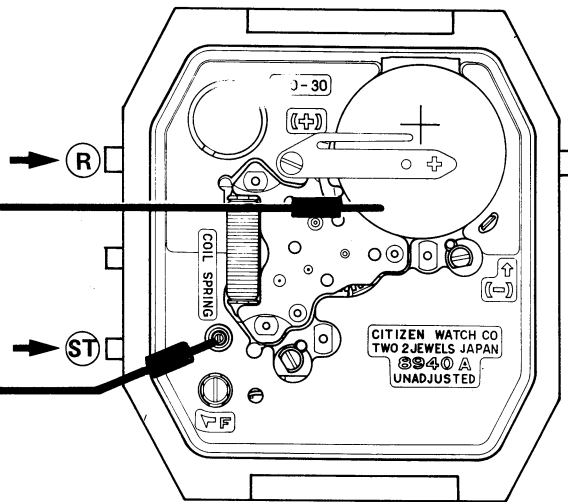
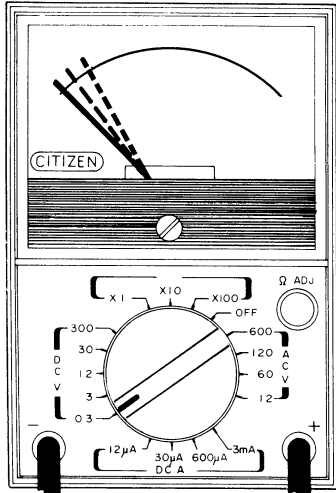

Pointer swinging

→ No fault with unit of electronic circuit

→ 2)

No swinging of pointer

→ Replacement of unit of electronic circuit

- 2) The following points are checked in case no fault is detected through the inspections of 1).
- (1) Whether the piezoelectric element of the vibrating plate has some cracking or breakage.
 - (2) Whether the buzzer contact spring has some bend or malformation and is set in the correct way.
 - (3) Whether some dust or stains are sticking to the pattern of the unit of electronic circuit.

Cracking or breakage detected

→ Replacement of vibrating plate



Bend or malformation of buzzer contact spring

→ Replacement of buzzer contact spring

Dust or stains sticking

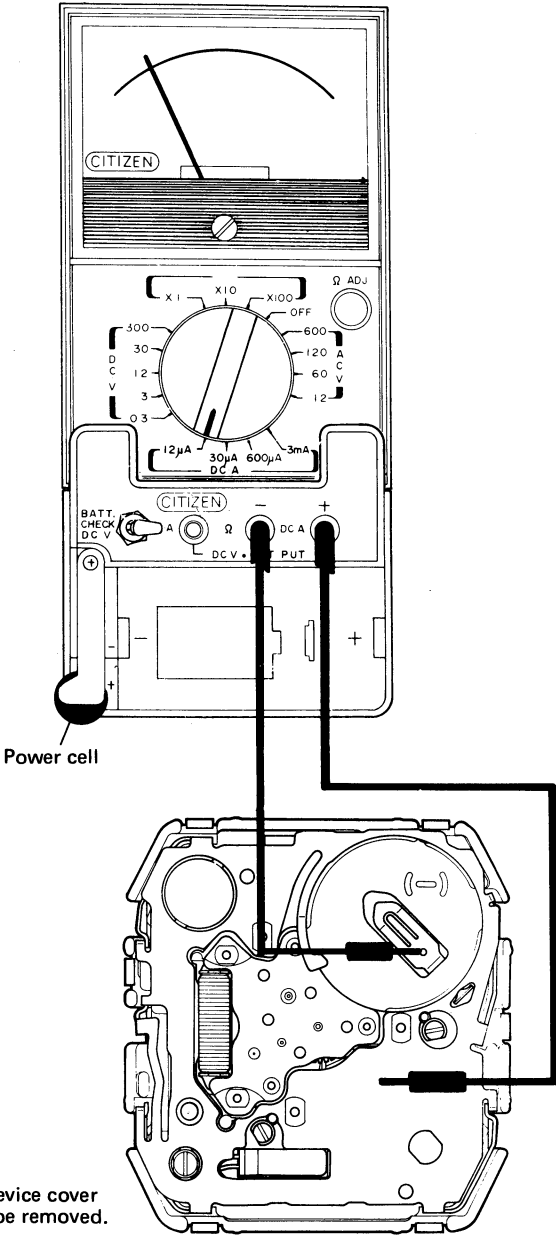
→ To be removed away

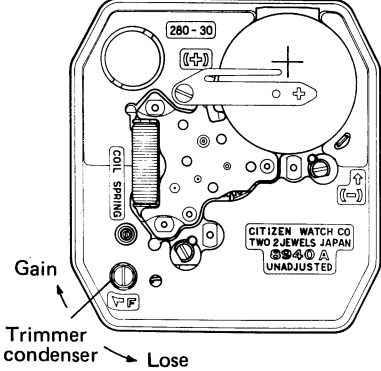
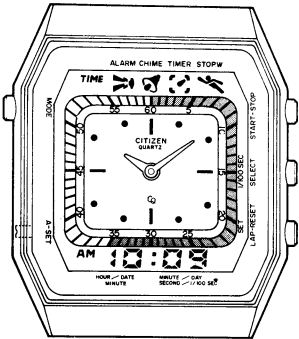
Checking items	How to check	Result and treatment
8 Measurement of power cell voltage	Refer to 1	
9 Measurement of power consumption	<p>The tester pointer may sometimes swings up to the limit when the lead terminal of the tester is applied to the measuring area. In this connection, the power consumption must be measured in the following procedure.</p> <ol style="list-style-type: none"> (1) The rotary switch of the tester is set to "3mA". (2) The lead terminal is applied to the measuring area, and then either of the switch springs corresponding to each push-button is pushed when the tester pointer swings. (3) The rotary switch is set to "12 A" when the pointer stands still at "0 A".  <p>The device cover must be removed.</p>	<ul style="list-style-type: none"> • Measurement in the mode of normal time display: <ul style="list-style-type: none"> Under 2.0μA → Normal Over 2.0μA → Measurement of power consumption of electronic circuit with LC display panel removed • Measurement with LC display panel removed <ul style="list-style-type: none"> Under 1.5μA → 2 Check of LC display panel contact part Over 1.5μA → Replacement of unit of electronic circuit

Checking items	How to check	Result and treatment
10 Time adjustment	<p>The time is adjusted by turning the trimmer condenser.</p>  <p>The diagram shows the internal movement of the watch. A trimmer condenser is located near the top center, with a screwdriver tip pointing to it. Below it, there are two adjustment points labeled 'Gain' and 'Lose'. The movement is labeled 'CITIZEN WATCH CO TWO JEWELS JAPAN 8940A UNADJUSTED'.</p>	
11 Check of appearance conditions and functions.	<p>Finally, the following points are checked with the finished watch.</p> <div style="display: flex; justify-content: space-around; align-items: center;"> <div style="text-align: center;">  <p>Cal. 8940</p> </div> <div style="text-align: center;">  <p>Cal. 8943</p> </div> </div> <ol style="list-style-type: none"> 1) Whether the figures or marks displayed have some defects. 2) Whether each operation of the functions is possible in the smooth and correct way. 3) Whether some dust or stains stick to the appearance function parts. <p>In addition, all segments glow up with the simultaneous push of (R), (S) and (ST) buttons, which can be applied to check the break of the segments.</p>	

CITIZEN WATCH CO., LTD.
Tokyo, Japan